

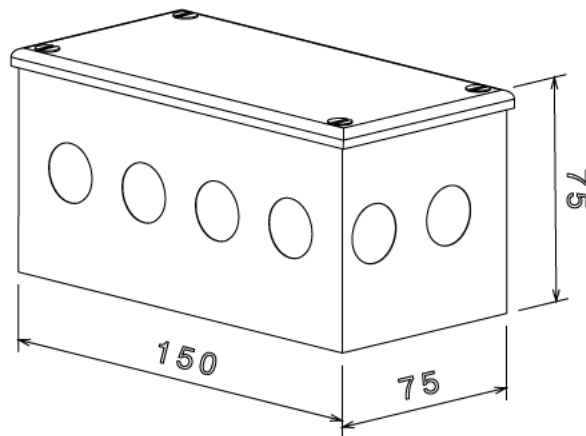

AB09G/K - ADAPTABLE BOX - KNOCK OUT

Description	AB09G/K - 150 x 75 x 75mm (6 x 3 x 3") Adaptable Box - Knock Out
Finish	Pre Galvanised Sheet Steel
Material	1.2mm Nominal Galvanised Steel Sheet to BS EN 50142 & 3
Packaging	Packed in qty 5 (Can be purchased individually)
Additional Notes	Comprises of Body, Flanged Cover and 4 Lid Fixing Screws Knock outs - 2 x 20mm (end face) 4 x 20mm (side face) Compliant To LU Standard 1-085 (For Use On Surface & Sub-Surface Locations)

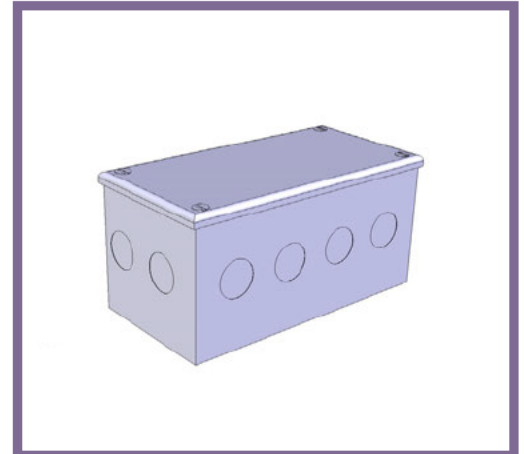

Isometric view

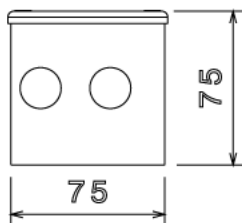

Front view

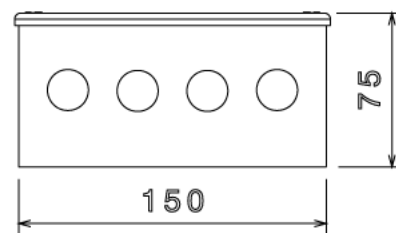

Side view

All measurements in mm unless otherwise stated