



## AB13G - ADAPTABLE BOX - PLAIN

**Description** AB13G - 150 x 150 x 50mm (6 x 6 x 2") Adaptable Box - Plain

**Finish** Pre Galvanised Sheet Steel

**Material** 1.2mm Nominal Galvanised Steel Sheet to BS EN 50142 & 3

**Packaging** Packed in qty 6 ( Can be purchased individually)

**Additional Notes** Comprises of Body, Flanged Cover and 4 Lid Fixing Screws  
Plain sides (This product is also available with pre-cut Knockouts)  
Compliant To LU Standard 1-085 ( For Use On Surface & Sub-Surface Locations)

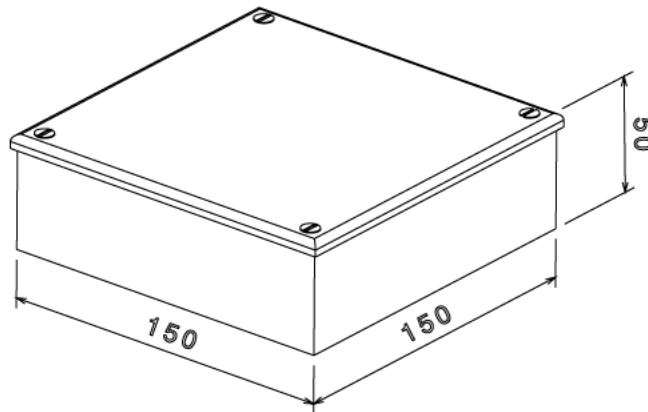
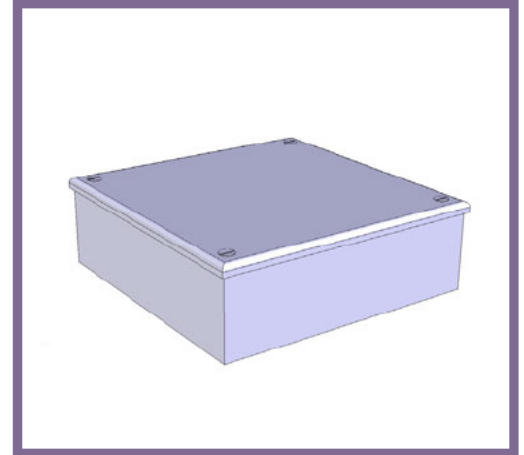

**Isometric view**

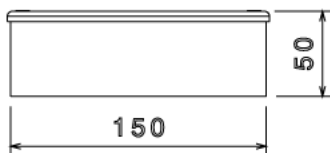

**Front view**

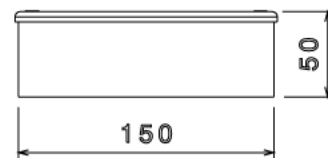

**Side view**

All measurements in mm unless otherwise stated