



AB17G - ADAPTABLE BOX - PLAIN

Description AB17G - 225 x 150 x 75mm (9 x 6 x 3") Adaptable Box - Plain

Finish Pre Galvanised Sheet Steel

Material 1.2mm Nominal Galvanised Steel Sheet to BS EN 50142 & 3

Packaging Packed in qty 5 (Can be purchased individually)

Additional Notes Comprises of Body, Flanged Cover and 4 Lid Fixing Screws
Plain sides (This product is also available with pre-cut Knockouts)
Compliant To LU Standard 1-085 (For Use On Surface & Sub-Surface Locations)

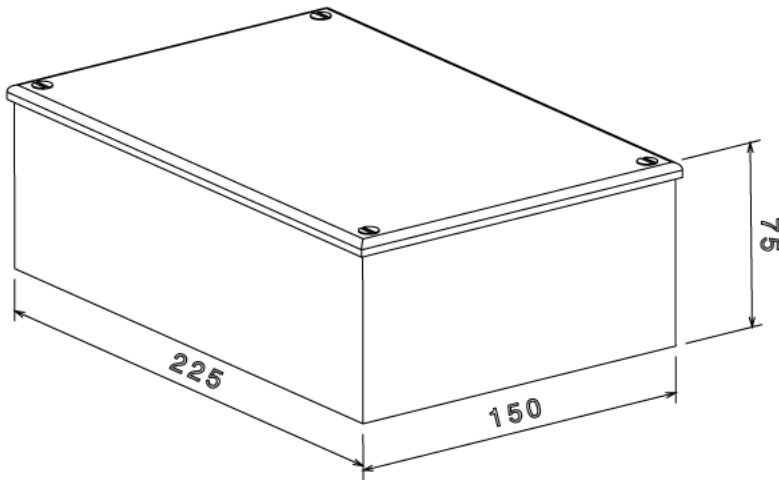
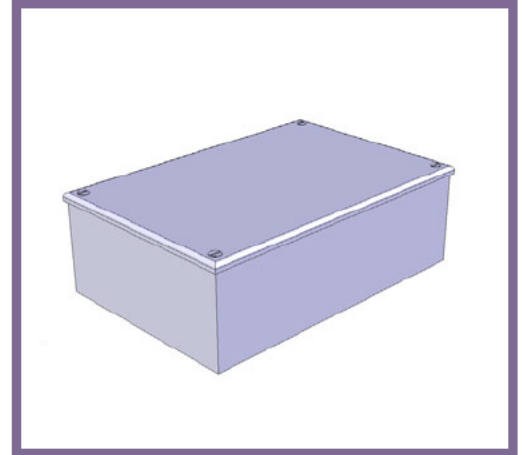

Isometric view

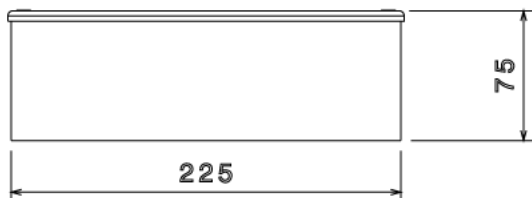

Front view

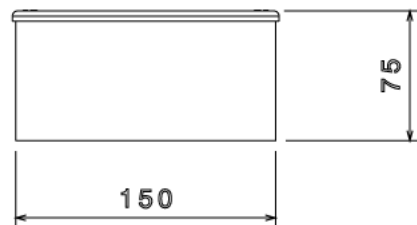

Side view

All measurements in mm unless otherwise stated