



## AB21G - ADAPTABLE BOX - PLAIN

**Description** AB21G - 225 x 225 x 100mm (9 x 9 x 4") Adaptable Box - Plain

**Finish** Pre Galvanised Sheet Steel

**Material** 1.2mm Nominal Galvanised Steel Sheet to BS EN 50142 & 3

**Packaging** Packed in qty 2 ( Can be purchased individually)

**Additional Notes** Comprises of Body, Flanged Cover and 4 Lid Fixing Screws  
Plain sides (This product is also available with pre-cut Knockouts)  
Compliant To LU Standard 1-085 ( For Use On Surface & Sub-Surface Locations)

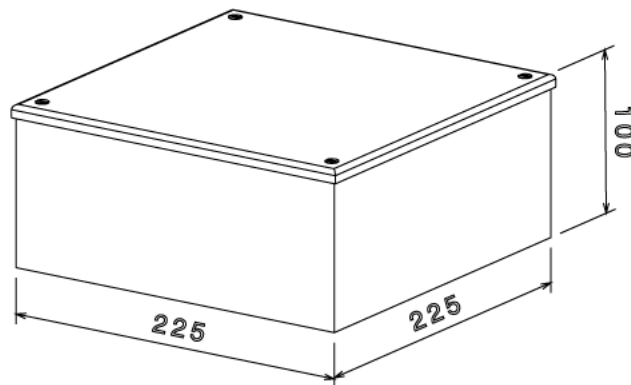
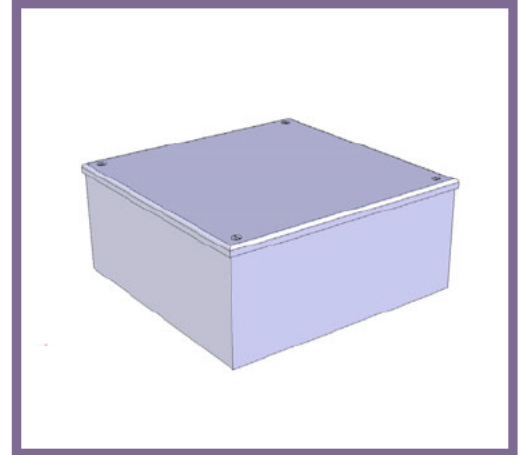

Isometric view

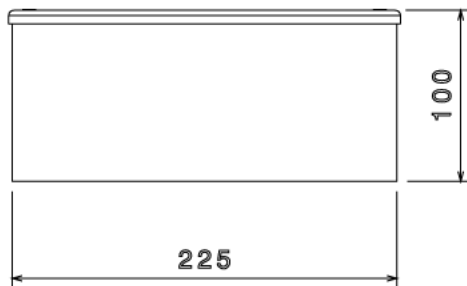

Front view

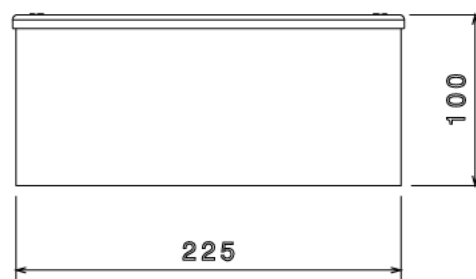

Side view

All measurements in mm unless otherwise stated