



HFN12 - HEXAGON FULL NUT

Description HFN12 - M12 Hexagon Full Nut

Finish BZP

Material Steel

Packaging Packed in qty 100

Additional Notes

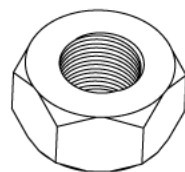
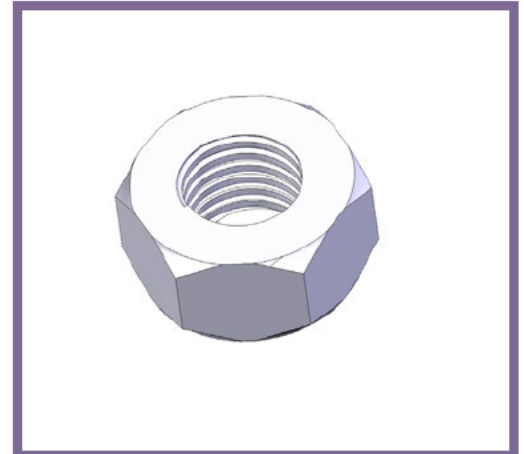

Isometric view

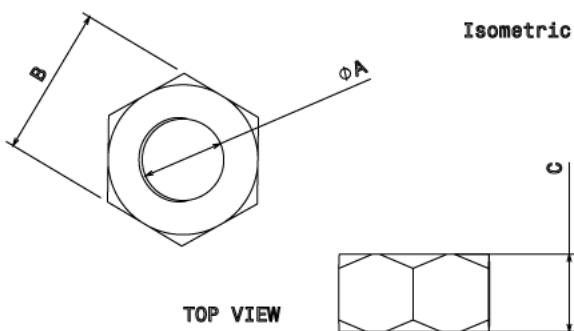

TOP VIEW

SIDE VIEW

CODE	A	B	C
HFN6	M6	9.8	5.1
HFN8	M8	12.8	6.30
HFN10	M10	16.75	7.80
HFN12	M12	18.8	9.75

All measurements in mm unless otherwise stated