



MP522 - CHANNEL CANTILEVER ARM

Description MP522 - 300mm Channel Cantilver Arm - 2 hole base plate

Finish Hot Dipped Galvanised

Material Steel

Packaging Supplied individually

Additional Notes Compliant to LU Standard 1-085
(For use on surface & sub-surface locations)

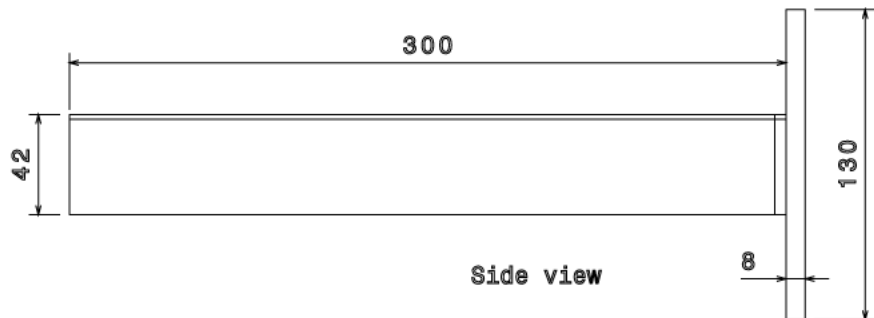
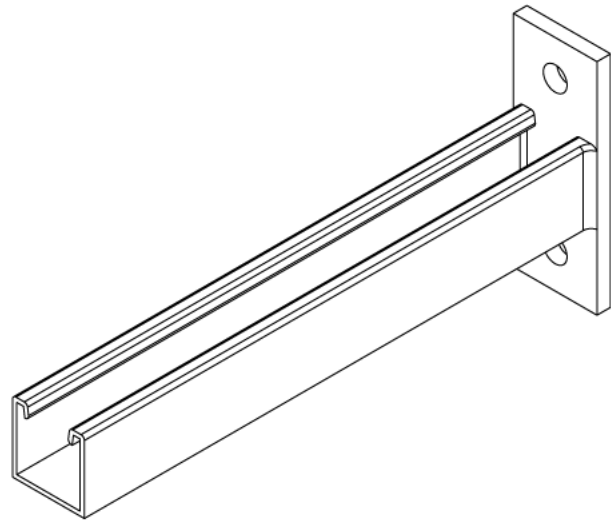
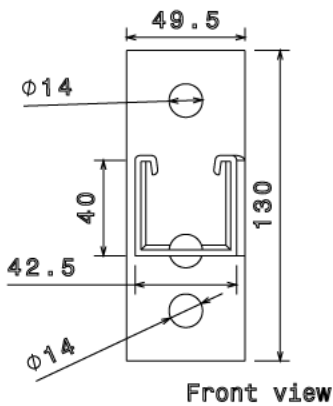
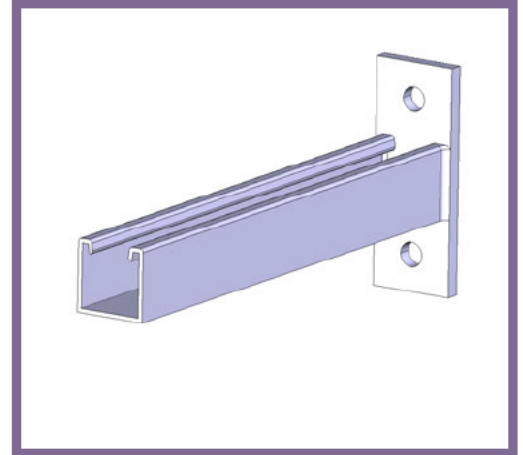

All measurements in mm unless otherwise stated