



PW12 - PENNY WASHER

Description PW12 - M12 Penny Washer 25mm outer Diameter

Finish BZP

Material Steel

Packaging Packed in qty 100

Additional Notes

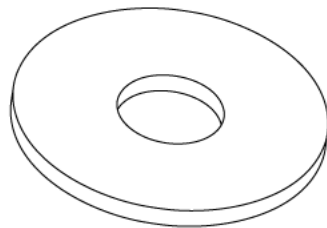
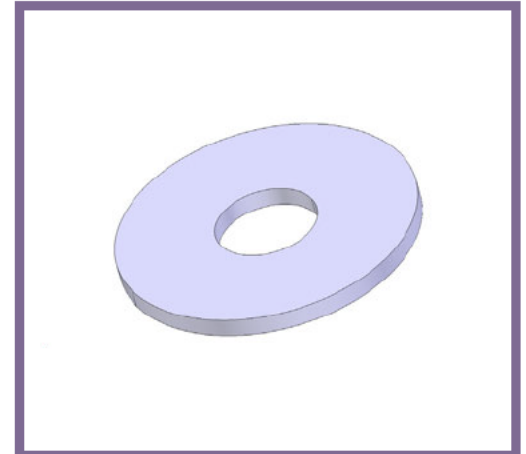

Isometric view

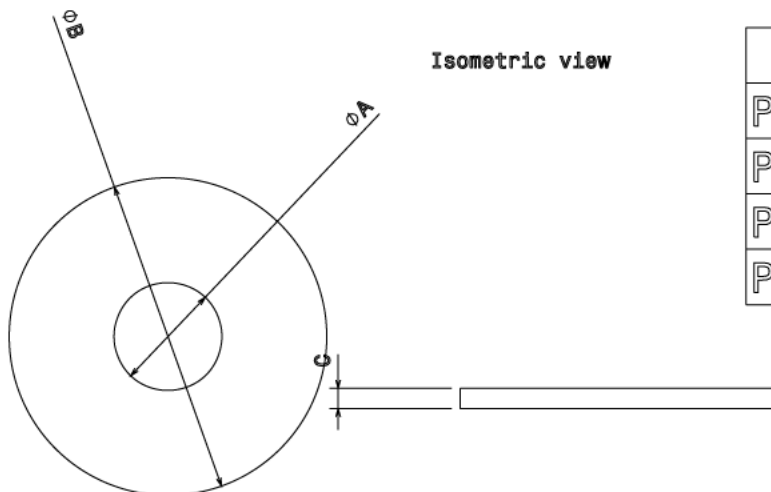

Top view

Side view

	A	B	C
PW6	M6	25	1.6
PW8	M8	25	1.6
PW10	M10	25	1.6
PW12	M12	25	1.6

All measurements in mm unless otherwise stated