



SR10 - EXTENSION RING

Description SR10G / B - 10mm Extension Ring

Finish BZP (G) or Black Enamel (B)

Material Steel

Packaging Packed in qty 50

Additional Notes

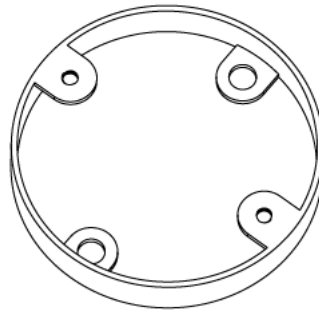
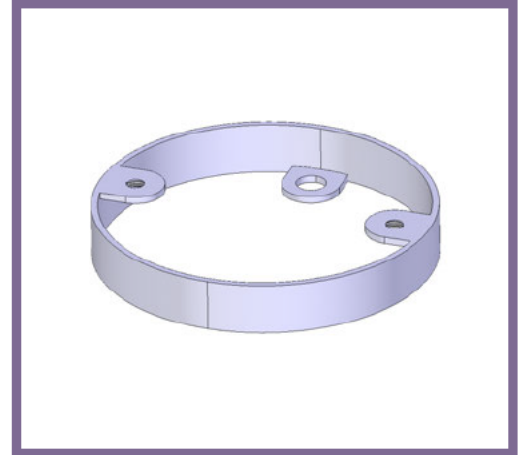

Isometric view

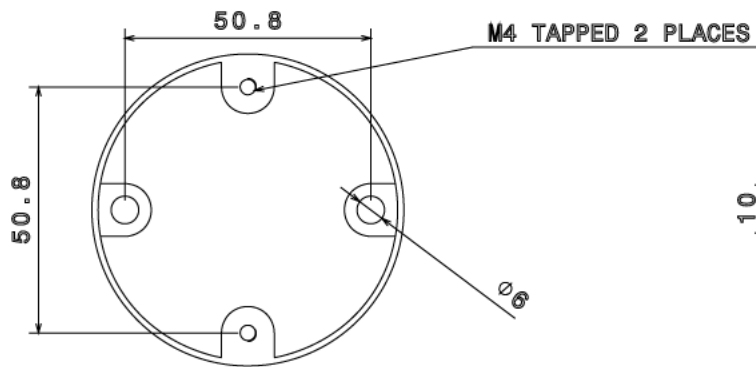

Top view

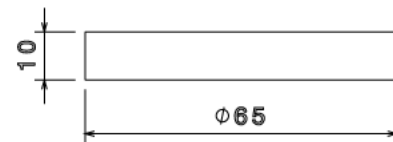

Side view

All measurements in mm unless otherwise stated